

SOLO

POWER REGULATOR CONTROL FOR ELECTRIC DRYER

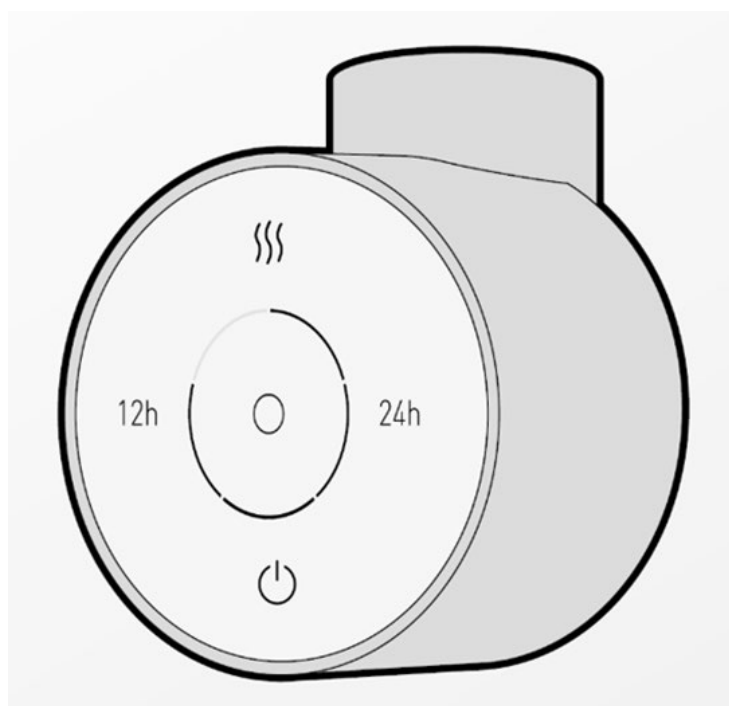

INSTALLATION, OPERATING AND USER MANUAL







THE WORK MUST ONLY BE CARRIED OUT BY QUALIFIED STAFF



nexus
easy connect

Prior to installing and using the temperature controller, please carefully read this manual and keep it for future reference

TABLE OF CONTENTS

1	General warnings 	4
1.1	Disclaimer	4
1.2	Warranty.....	4
1.3	Product compliance.....	4
1.4	General Warnings.....	4
1.5	Safety Warnings 	5
2	Product presentation	6
3	Symbols And Glossary.....	6
4	Technical Specification Tables	8
5	Installation – Qualified technicians only	9
5.1	Before you start.....	9
5.2	Towel Rail Warnings 	10
5.3	Power supply Warnings 	10
5.4	SOLO position.....	11
5.4.1	TOWEL RAIL POSITION.....	11
5.4.2	SUPPLY CORD POSITION	12
5.4.3	SOLO REGULATING BOX POSITION	12
5.5	SOLO installation.....	13
5.6	Cleaning	15
5.7	Uninstalling SOLO	15
5.8	Notes for disposal of SOLO valid for the European Union	15
6	Use and functioning.....	15
7	Controller Functions	17
7.1	Basic Operating modes and statuses.....	17
7.2	Advanced operating modes	18
7.2.1	12h TIMER functioning	18
7.2.2	24h TIMER functioning	19
7.3	Settings and other functions	20
7.3.1	Power range setting.....	20
7.3.2	Default timer duration in 12h-24h timer	21
7.3.3	Lock screen	22
7.3.4	Factory reset.....	22
8	Maintenance	23
9	Diagnostics	23

10	Supplied accessories, consumables and spare parts.....	24
11	Power cable size reduction	24

1 GENERAL WARNINGS

1.1 Disclaimer

The manufacturer declines all responsibility for any inaccuracies in this document due to printing or transcription errors. It reserves the right to make any alterations to its products deemed necessary or useful. The manufacturer will not be held responsible for faults due to incorrect installation.

1.2 Warranty

SOLO is guaranteed against defects in materials and/or workmanship for a period of twenty-four (24) months from the date of purchase.

The guarantee will not be effective if the faults found are ascribable to the Buyer's carelessness and/or if the Products have not been used according to their technical specifications and in the event of wrong maintenance by non-authorized engineers, cleaning with unsuitable procedures or materials, improper storage, handling and transport, or any other circumstances that cannot be ascribed to manufacturing defects for which manufacturer is responsible.

The guarantee of SOLO is not valid in case of improper use or wrong installation.

1.3 Product compliance

APPLICABLE EUROPEAN DIRECTIVES AND STANDARDS

Applicable Directives

2014/35/EU Low Voltage Directive (LVD)

2014/30/EU Electromagnetic Compatibility Directive (EMC)

2011/65/EU RoHS II Directive, Regulation REACH (EC 1907/2006)

2012/19/EU WEEE Directive

Electric dryer operation is in full compliance with EN 60335-2-43

1.4 General Warnings

- Read the instructions carefully before installing and using the electronic control (hereinafter referred to as SOLO or appliance) and retain the instructions for future reference.
- Installation of SOLO must be performed only by qualified technicians which assume complete responsibility for the definitive installation and consequent good functioning of the product installed.
- Installation must be compliant with all applicable safety regulations and laws, national, regional, provincial and town council Standards present in force in the Country in which the final product has been installed, as well as the instructions contained in this manual. The Manufacturer cannot be held responsible for the failure to comply with such precautions.

1.5 Safety Warnings

- Children of less than 3 years must be kept away unless continuously supervised.
- This appliance can be used by children aged from 8 years or over and by persons with reduced physical, sensory or mental capabilities or lack of experience and knowledge if they have been given supervision or instruction concerning use of the appliance in a safe way and they understand the hazards involved. Children shall not play with the appliance.
- Cleaning and user maintenance shall not be made by children without supervision.
- Children aged from 3 years and less than 8 years shall only switch on/off the appliance provided that it has been placed or installed in its intended normal operating position and they have been given supervision or instruction concerning use of the appliance in a safe way and understand the hazards involved. Children aged from 3 years and less than 8 years shall not plug in, regulate and clean the appliance or perform user maintenance.
- **CAUTION** — Some parts of this appliance can become hot and may cause burns. Precautions should be taken to ensure that prolonged contact with the el. dryer cannot occur. Particular care should be taken in confined areas where accidental prolonged contact with the el. dryer could be more likely to occur. Particular attention has to be given where children and vulnerable people are present.
- **WARNING:** In order to avoid a hazard for very young children, this appliance must be installed so that the lowest heated rail is at least 600 mm above the floor (see Figure 3).
- **IMPORTANT:** In order to disconnect the incoming supply for the purpose of isolation during installation and maintenance it is recommended for the distributor's service fuse to be withdrawn or the circuit breaker at the distribution board to be switched off whilst work is in progress.
- Do not install SOLO with an electric heating element not equipped with pre-set protection devices designed to prevent over-heating of the el. dryer in abnormal conditions.
- Do not power SOLO on before it has been completely installed in a properly filled towel rail with the electric heating element recommended by the manufacturer
- Check that the electricity supply system is connected through an MCB (Magnetothermic Circuit Breaker) and a high sensitivity current differential and overcurrent relay of 30 mA RCCB (Residual Current Circuit Breaker) connected directly to the socket or connection box in use.
- If SOLO is not fitted with a supply cord with a plug, an omni-pole disconnection from the supply is required, incorporated in the fixed wiring, in accordance with the wiring rules. Switches intended to ensure all-pole disconnection must be directly connected with the supply terminals and must have a contacts distance of at least 3 mm in each pole. The switch intended to ensure all-pole disconnection must be dedicated exclusively to the appliance.
- SOLO is suitable for use on an A.C.~ electrical supply. Before installation check that the supply voltage corresponds with that marked on the electronic control.
- Do not insert metal objects or fingers or any other objects, even temporarily, into the connection areas where SOLO is connected to the towel rail.

- This appliance should only be used to dry fabrics washed in water using commonly available detergents. Avoid direct contact of SOLO with any chemical product or alcohol, including the liquid contained in the towel rail.

2 PRODUCT PRESENTATION

This product is an electrical / electronic component designed to be assembled, used and possibly replaced in case of failure uniquely in the specific equipment for which it is intended.

SOLO is an electronic power regulator designed for regulating the thermal power of an electric heating element installed in the el. dryer configured for drying towels washed in water. Any other use is strictly forbidden. The type of regulation consists of an ON-OFF electronic open-loop controller.

SOLO can be connected to a fully electric towel dryer or a hybrid electric-hot water heater (dual fuel, central heating dryer).

3 SYMBOLS AND GLOSSARY

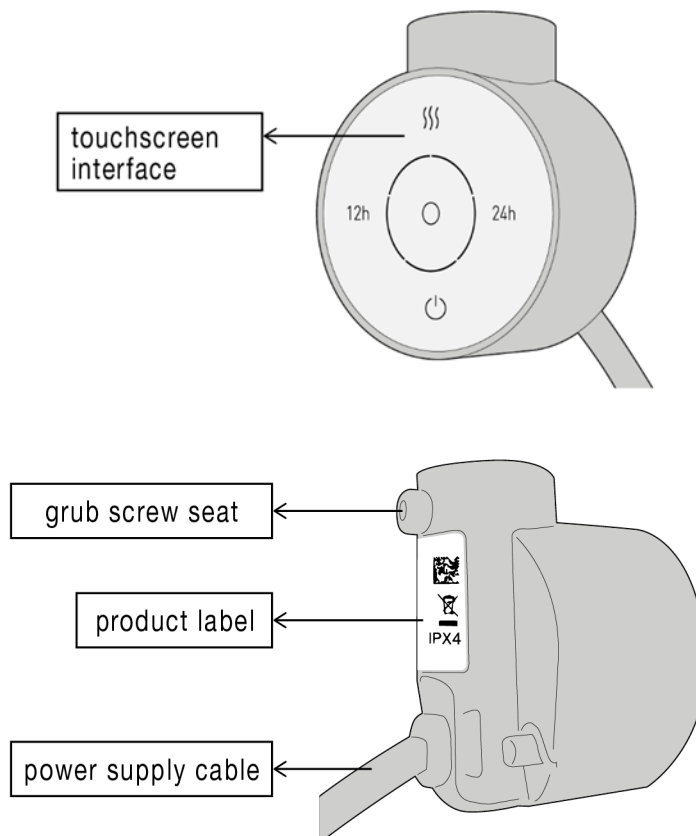

Figure 1: Components of SOLO regulating box (front and back view)

Component	Description
Touchscreen interface	Capacitive touchscreen interface displaying current system status (in black or white)
Grub screw seat	Position of the grub screw in order to fix SOLO to the Electric heating element connection
Power supply cable	230 V power supply cable with plug

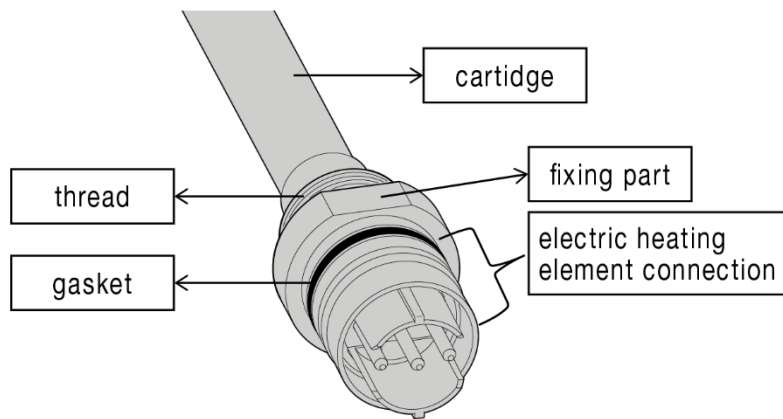



Figure 2: Electric heating element components

Electric Heating Element Component	Description
Cartridge	Heating part of the electric heating element
Thread	Connection part to be fitted into the towel rail
Fixing part	Necessary part to tighten the electric heating element into the towel rail with a 25 mm wrench
Gasket	O-ring gasket designed to be compressed between the electric heating element connection and the upper plastic part of the SOLO in order to prevent water leakage
Electric heating element connection – Nexus connector	part necessary for coupling with SOLO (and other compatible controllers with Nexus Easy Connect)

STANDARD PROVIDED KIT

Element	Description	
<p>O-Ring gasket</p> <p>Grub screw</p> <p>Allen key</p>	<p>22mm x 1mm gasket designed to allow SOLO coupling with the electric heating element connection part</p> <p>A headless screw having a socket for a hexagon Allen key used to secure the plastic housings of the SOLO onto the electric heating element connection, into the <i>grub screw seat</i> (Figure 1)</p>	

4 TECHNICAL SPECIFICATION TABLES

SOLO and the electric heating element power must be carefully selected in proportion to towel rail size and thermal output. To select SOLO and the heating element electrical power, please refer to the el. dryer manufacturer instructions, when a certification related to the complete system (according to EN 60335-2-43) issued by an European recognized institute (like SEMKO, VDE, IMQ...) is available. The installer shall verify that SOLO System operates in conformity with Table 2.

Electric heating element

Power (W)	200	400	600	800	1000	1200
Length (mm)	320	480	680	820	980	1150

Table 1

SOLO	
Power supply	230 V / 50 Hz
Electric Heating element power	200 ÷ 1200 W
Insulation class	Class I
Colours and finishing	White or Chrome
Touch interface display	White or black
Dimensions	61.5 x 70 x 50 mm

Water protection rating	IPX4
Maximum altitude above sea level	2000m
Operating ambient temperature	0°C ÷ 40°C
Storage temperature	-20°C ÷ 70°C
Max Humidity Level	RH 85% at 25°C (without condensation)
Power regulation range	5 levels adjustable by settings based on electric heating element power capacity Level 1: 20% of maximum power Level 2: 40% of maximum power Level 3: 60% of maximum power Level 4: 80% of maximum power Level 5: 100% of maximum power

Table 2

5 INSTALLATION – QUALIFIED TECHNICIANS ONLY



ALL ELECTRICAL INSTALLATION WORK MUST BE CARRIED OUT BY A QUALIFIED ELECTRICIAN



Read the general warnings and safety warnings before installation.

IMPORTANT: Always disconnect the electricity supply from the mains during installation and maintenance. It is recommended that the fuse is withdrawn, or circuit breaker switched off at the distribution board while work is in progress (turning off the switch is not sufficient).

During installation, de-installation and maintenance, ensure working place safety until the operation is completed.

5.1 Before you start

- Avoid collisions during the handling. Do not deform SOLO.
- Avoid the contact of cables and of parts of the SOLO with sharpening corners and do not cause squashing.
- Do not subject the cables to traction. Do not apply concentrated pressures on the SOLO surface.
- Any contact between plastic parts of SOLO and chemical products or alcohol (including the water or the mixture water+ glycol inside the el. dryer) must be avoided.

- Check the pack to ensure you have all of the parts listed at paragraph 3 with no visible signs of damage. Make sure that SOLO parts are completely dry and have no defects. If any of the part is missing or appears damaged, you should return the device to the point of purchase.
- When you are ready to start, make sure that you have the right tools at hand, plenty of space and a clean dry area for assembly.
- Installation must be carried out in accordance with current standards and laws in force in the country in which the system is installed.
- Before installation, never switch the SOLO on to verify functioning effectiveness.
- Don't use the SOLO regulating box to lean the electrical towel rail on the floor as you can damage the plastic housing and water can penetrate inside with a risk of electrical shock.

5.2 Towel Rail Warnings

- The electrical dryer use is intended only for drying towels washed in water. Any other use is forbidden.
- The heating element must be fitted in the towel rail before mounting the rail to the wall.
- The towel rail has to be mounted parallel to the wall using the brackets recommended by the towel rail manufacturer. In order to avoid a hazard for younger children, the electrical towel rail should be installed so that its bottom part is at least 600mm above the floor according to EN 60335-2-43/A1.
- In Electric SOLO installation, fill the towel rail with certain percentage of water according to the towel rail manufacturer instructions. In case of missing instructions, we recommend to fill the towel rail with approximately 90% pure water and glycol mixture.
- In Electric SOLO installation the towel rail must have a sufficient air gap to allow for water expansion.
- Making sure that the SOLO heating element is completely immersed in water.
- All metallic parts of the electrical dryer fitted with SOLO and powered must not exceed the temperature limits according to the applicable standard also in case of SOLO continuously powering the electric heating element.
For all other aspects, refer to EN 60335-1, EN 60335-2-43.

5.3 Power supply Warnings

- Do not connect SOLO to the power supply until the installation into a properly filled el. dryer is completed.
- Make sure that the power lines are appropriate for the load required according to technical specification tables (see part 4).

- *Class I* SOLO (with yellow-green wire or earthed plug) must ONLY be connected to sockets or connector blocks with earthed contacts according to national standards and wiring regulations in force
- Protect the electricity supply with an RCCB (Residual Current Circuit Breaker) device.
- The electrical heating element must be connected to a suitable electricity supply by way of the cable provided. This should be via a fused spur in accordance with the IEE Wiring Regulations. If sited in the bathroom, the Fused Connection Unit must be located out of reach of persons using the basin, shower or bath. If in doubt, consult a qualified electrician.

SOLO supply cord

WITH plug

The socket and electricity supply must be appropriate for the required power. Do not use extensions.

The socket must be compatible with the SOLO supply cord plug. Do not use adapters.

5.4 SOLO position

SOLO must be fitted into the towel rail BEFORE mounting the towel rail to the wall.

5.4.1 TOWEL RAIL POSITION

WARNING: In order to avoid a hazard for very young children, this appliance should be installed so that the lowest heated rail is at least 600 mm above the floor (Figure 3).

- Do not install SOLO into a towel rail fitted in ZONE 0 or ZONE 1 (Zone definition IEC 60364-7-701 in Figure 3).
- The towel rail must be installed in a completely vertical wall.
- The el. dryer has to be mounted parallel to the wall using the brackets recommended by the towel rail manufacturer.
- SOLO is protected against water ingress according to its IPX4 degree of protection. The el. dryer where SOLO is fitted must be mounted inside the zone of the bathroom according to its IP degree of protection and electrical legislation in force. In case of doubt about the correct installation zone, refer to the relevant public institution.

- SOLO must not be within reach of people using the basin, shower or bath.

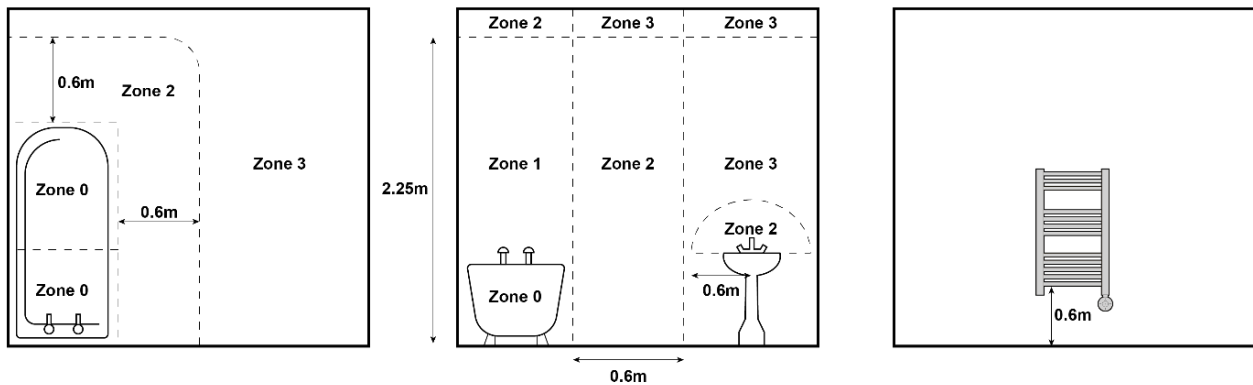

Figure 3

5.4.2 SUPPLY CORD POSITION

The supply cord must be connected to a proper socket or to a non-switched fused spur (without an intermediate plug for SOLO supplied without plug) which must be at least 25 cm from the floor according to the wiring regulations in force in the country where the installation is carried out. Figure 4 shows examples of positioning of the system.

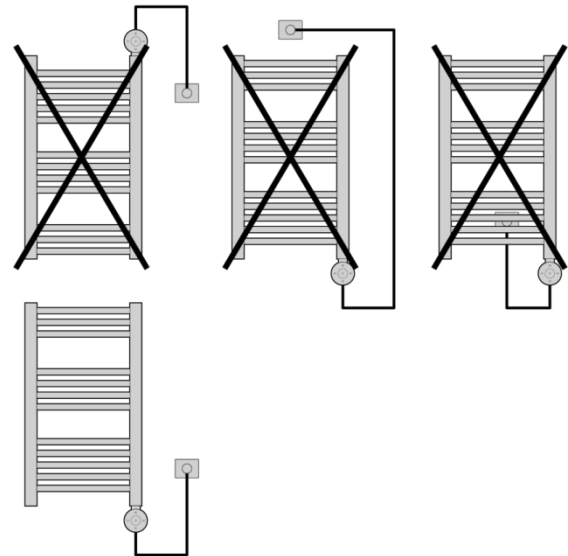

Figure 4 SOLO positioning

5.4.3 SOLO REGULATING BOX POSITION

- SOLO must only be fitted vertically in the bottom part of the towel rail.
- Electrical dryer must NOT be installed with the SOLO regulating box located at the top. This can seriously damage the control box and create a dangerous situation with a risk of fire.
- SOLO must be installed at distance of 40 mm (minimum) and 80 mm (maximum) from the wall. Figure 5 shows the optimal positions for the SOLO.

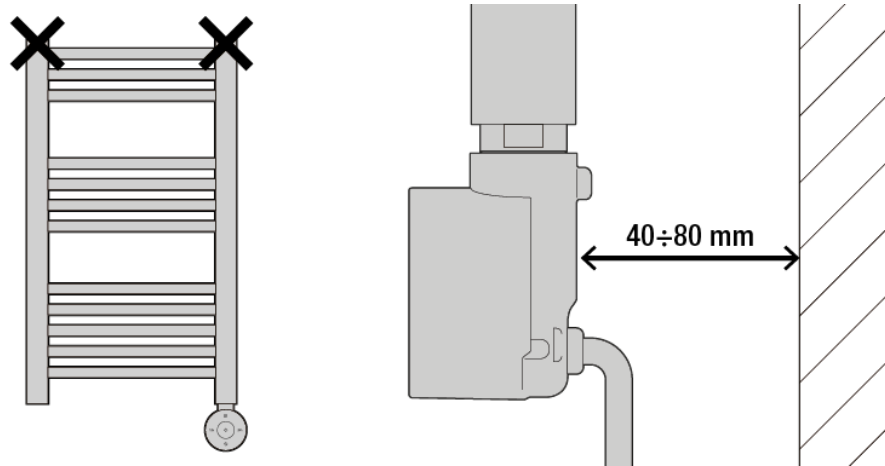

Figure 5 SOLO positioning

5.5 SOLO installation

ATTENTION! Be careful when handling the regulator, especially when putting it on!

1. SOLO'S CONNECTION AND COUPLING

- a. Insert SOLO into the electric heating element connection, applying slight pressure until SOLO is fully inserted.
- b. Keep SOLO pressed against the heating element in the towel rail and insert the provided grub screw into its spot; make sure there is no room between the device and the electric heating element fixing part (see part 3).

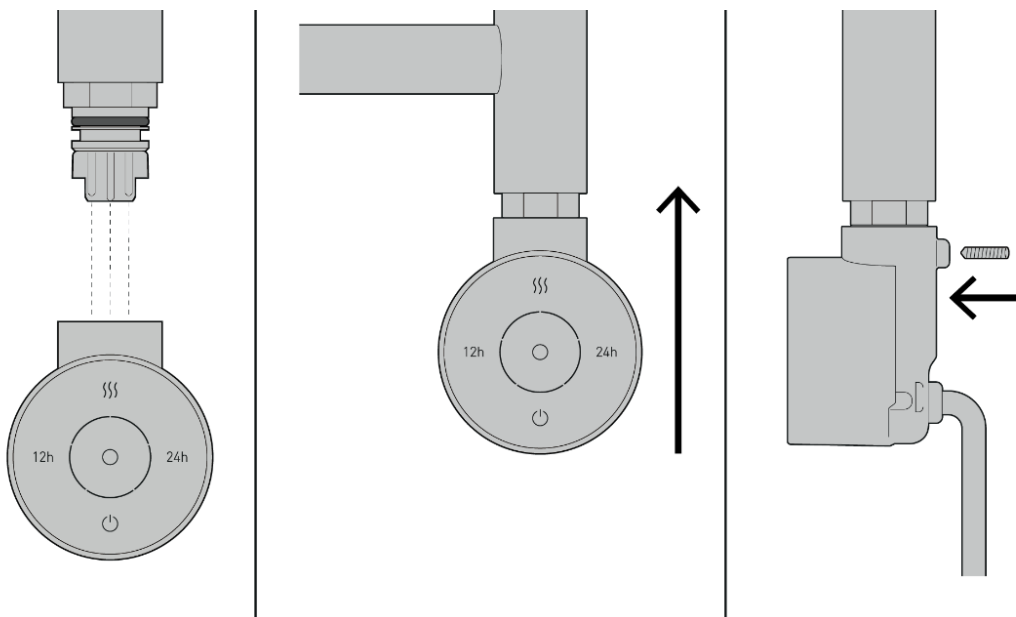

2. GRUB SCREW INSERTION

- a. Keeping SOLO pressed against the heating element in the towel rail, make sure the grub screw is in its right positioning spot (grub screw seat) as shown in figure below.
- b. Using the provided Allen key tighten the grub screw until it comes into contact and it is fully inserted in its spot, so that the SOLO is securely fixed to the electric heating element and the O-ring gasket is well in contact with both surfaces
- c. Make sure the grub screw is NOT in other wrong positions by checking the alignment with the back of SOLO, as shown in figure below.

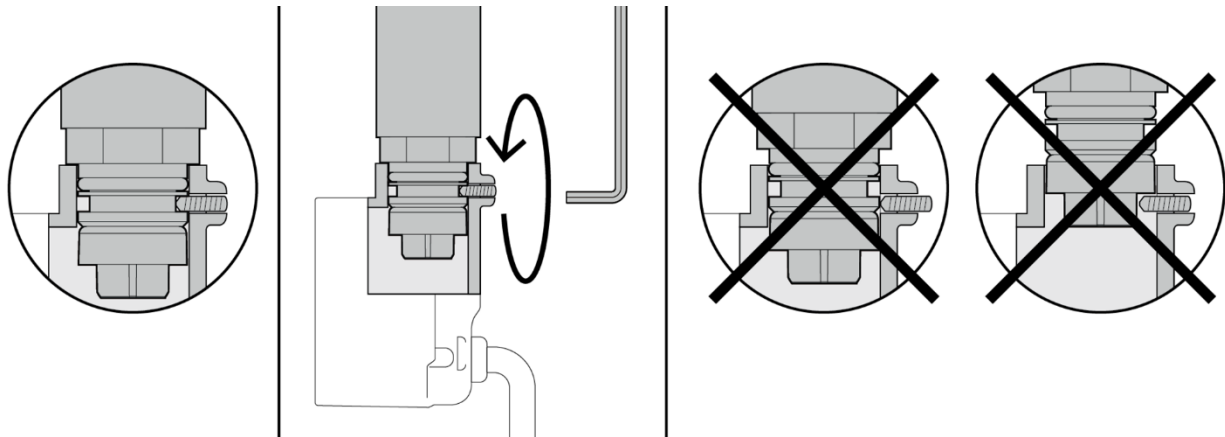

3. TOWEL RAIL INSTALLATION

If the display is facing the wall after tightening the heater, always adjust the heating element by turning it anti-clockwise with the 25mm spanner. The seal is designed to adjust to a certain amount of releasing without starting to leak.

- Install properly the el. dryer with the SOLO into the wall according to towel rail manufacturer instructions (See part 5.2).

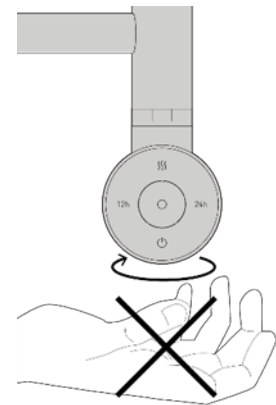

4. CONNECTION TO THE MAINS

- a. Connect the SOLO cable to the mains power according to current wiring regulations in force in the country where the product is installed. Make sure that the power lines are appropriate for the load required.
- b. Check electric strength on the appliance after fitting SOLO to the towel rail according to the instructions in Appendix A of EN60335-1: "Routine tests".
- c. In case of *Class I* controls, check earthing continuity on the appliance after fitting SOLO to the towel rail according to the instructions in Appendix A of EN60335-1: "Routine tests".

5.6 Cleaning

To clean SOLO, use only a dry and clean soft cloth.

Make small locally round movements.

Apply a light pressure especially to the chrome plastic surfaces to avoid potential scratches.

Do not clean SOLO with aggressive products.

Do not wet SOLO in an attempt to clean it. Do not immerse in water.

When cleaning SOLO, it must be disconnected from the power supply.

5.7 Uninstalling SOLO

ALL ELECTRICAL WORK SHOULD BE CARRIED OUT BY A QUALIFIED ELECTRICIAN.

Do not touch the metallic parts of SOLO if it is powered; before maintenance and de-installation operation wait the necessary time to ensure it is cold after it is switched off.

During installation, de-installation and maintenance, ensure working place safety until the operation is completed.

5.8 Notes for disposal of SOLO valid for the European Union



The crossed-out wheeled-bin symbol on the el. dryer to which SOLO is installed, reminds you that in the European Union all electrical and electronic products and batteries must be taken to separate collection at the end of their working life. Do not dispose of these products as unsorted municipal waste. Return the products to

collection to prevent possible harm to the environment or human health from uncontrolled waste disposal and to promote the sustainable reuse of material resources. Collection information is available from the product retailer, local waste authorities or national producer responsibility organizations. For more information, see product country-specific information.

6 USE AND FUNCTIONING

All uses different from the ones described in this section are to be intended as improper usage. In case of doubts refer to the seller.

- The electrical dryer is intended only for drying towels washed in water. Any other use is forbidden
- SOLO is intended to be used and installed into a towel rail. Any other use is strictly forbidden and potentially dangerous.
- Do not switch on SOLO unless the heating element is properly immersed in the liquid inside the el. dryers.

- SOLO is intended to work only if the electric heating element - connected to SOLO and fitted into the towel rail - is completely immersed in the liquid (water) inside the el. dryer.
- SOLO is designed for use with water or water + glycol filled el. dryers.
- Do not use SOLO before it has been completely and correctly installed. If SOLO is not firmly fixed to the el. dryer, disconnect the mains turning off the circuit breaker switch and contact the manufacturer in order to avoid hazard.
- Do not cut the power supply cable to stop regulation or to switch SOLO OFF.
- Once connected to the heating element, SOLO regulating box **MUST NOT** be disconnected from the heating element.
- Do not cover SOLO, even partially, even temporarily.

7 CONTROLLER FUNCTIONS

7.1 Basic Operating modes and statuses

MODE	OPERATIONS	CURRENT STATUS DISPLAYED (black display and white display)
------	------------	--

STAND-BY

Touch  to turn STAND-BY ON/OFF.

The display is ready to receive commands for 30 seconds. After that, the display shows the CURRENT STATUS of the system. To activate again the display, tap .

MANUAL

Constant power level 1-5 (see 7.3 to edit default values)

Tap  to set the desired power level.

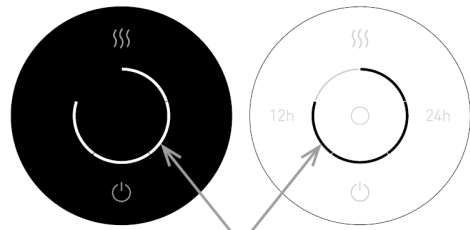



number of segments indicating the power level.

BOOST

Constant maximum power for 1-5h

 you can activate BOOST mode even when the device is in STAND-BY mode

Tap  until the icon turns red
Tap  to customize the countdown value (from 1 to 5 hours. Default value is 2 hours).

At the end of the countdown, the system will automatically set to the previous mode.

To go back to previous mode:
Tap  until the icon turns white.

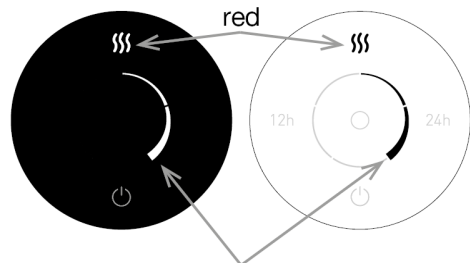

number of segments indicating how many hours to the end of countdown.

ANTIFREEZE

Constant power to prevent freezing ($7\pm 3^{\circ}\text{C}$)

In MANUAL mode:
Tap  until the icon turns blue.

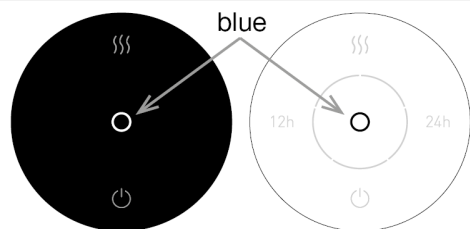

7.2 Advanced operating modes

7.2.1 12h TIMER functioning

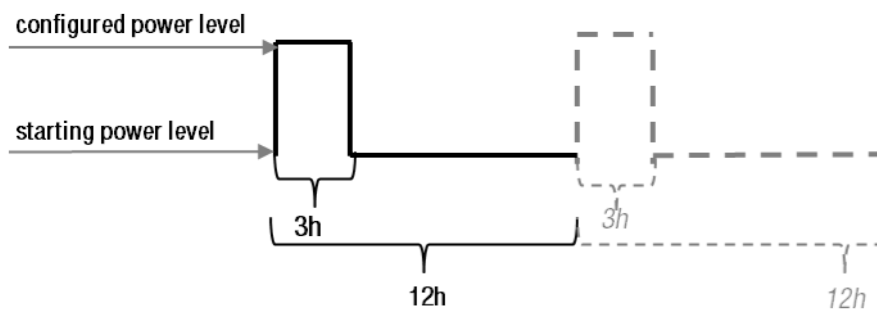

Configured power level (1-5) that repeats every 12 hours (for timer duration customization see 7.3).

Use this mode if you wish to warm up your el. dryer at a configured power level automatically every 12 hours as shown below. Activate this mode **at the exact time** you wish to warm up your el. dryer at a configured power level (for 3 hours duration according to factory settings).



In MANUAL mode or in ANTIFREEZE mode:

NOTE: after 10 seconds of no interaction, the device will go back to previous modality without saving any operation.

1. press and hold  until timer icons flash
2. tap 12h to select the timer
3. tap  until your desired power level
4. tap 12h again to confirm.

At the end of timer countdown, 12h icon will turn white to indicate that a 12h timer is scheduled.

To cancel 12h TIMER:

Press and hold 12h for 5 seconds

CURRENT STATUS displayed (black display and white display)

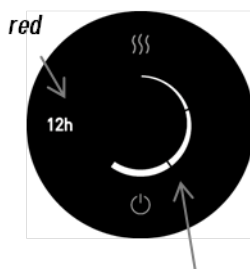

number of sliding segments indicates how many hours to the end of the countdown

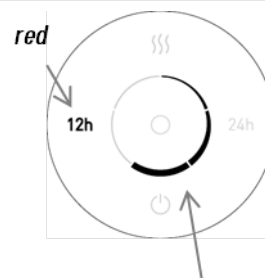

number of sliding segments indicates how many hours to the end of the countdown



you can **change the configured power level** anytime while the 12h icon is red (during timer functioning) without losing the starting time of the timer. The device will save the last configured power level.



even during 12 h timer you can **activate BOOST** mode

7.2.2 24h TIMER functioning

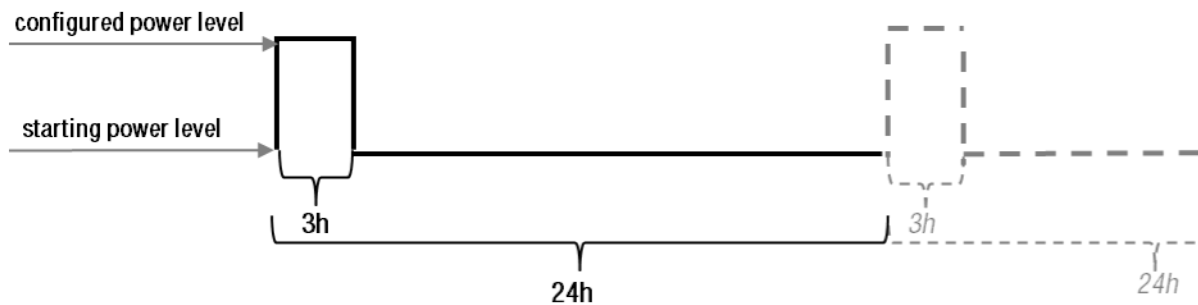

Configured power level (1-5) that repeats every 24 hours (for timer duration customization see 7.3).

Use this mode if you wish to warm up your el. dryer at a configured power level automatically every 24 hours as shown below. Activate this mode **at the exact time** you wish to warm up your el. dryer at a configured power level (for 3 hours duration according to factory settings).



In MANUAL mode or in ANTIFREEZE mode:

NOTE: after 10 seconds of no interaction, the device will go back to previous modality without saving any operation.

1. press and hold  until timer icons flash
2. tap 24h to select the timer
3. tap  until your desired power level
4. tap 24h again to confirm

At the end of timer countdown, 24h icon will turn white to indicate that a 12h timer is scheduled.

To cancel 24h TIMER:

Press and hold 24h for 5 seconds

CURRENT STATUS Displayed (black display and white display)

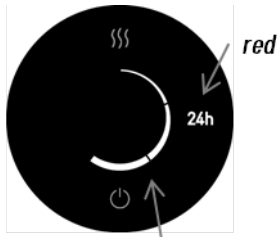

number of sliding segments indicates how many hours to the end of the countdown

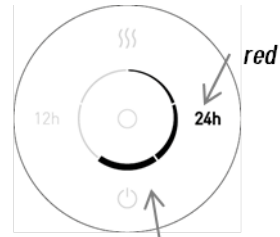

number of sliding segments indicates how many hours to the end of the countdown



you can **change the configured power level** anytime while the 24h icon is red (during timer functioning) without losing the starting time of the timer. The device will save the last configured power level.



even during 24 h timer you can **activate BOOST** mode

7.3 Settings and other functions





7.3.1 Power range setting

Choose your preferred working power range among 5 different sets: SOLO will work within the power range you set (minimum power level is 20% in every set, maximum and intermediate power varies according to the table below).

	Power ranges					setting
	20%	40%	60%	80%	100%	
<u>default set</u> →						5 segments
4 TH RANGE	16%	32%	48%	64%	80%	4 segments
3 RD RANGE	14%	28%	42%	56%	70%	3 segments
2 ND RANGE	10%	20%	30%	40%	50%	2 segments
1 ST RANGE	8%	16%	24%	32%	40%	1 segment

In ANTIFREEZE mode:

NOTE: after 10 seconds of no interaction, the device will go back to previous modality without saving any operation

- 1- press and hold  until  starts flashing
- 2- tap  and select your desired power range as shown in the table
- 3- tap  to save

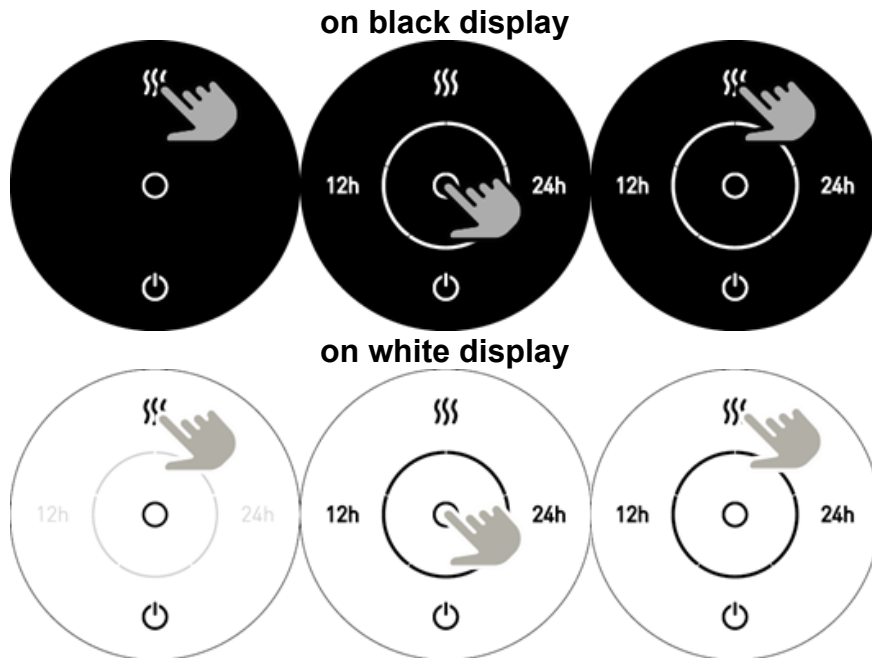





7.3.2 Default timer duration in 12h-24h timer

Customizes timer duration of 12h and 24h timer

In ANTIFREEZE mode:

NOTE: after 10 seconds of no interaction, the device will go back to previous modality without saving any operation

- 1- press and hold  until  starts flashing
- 2- select 12h or 24h to customize the selected timer: the selected icon will start flashing
- 3- tap  until desired timer duration value
- 4- tap  to save

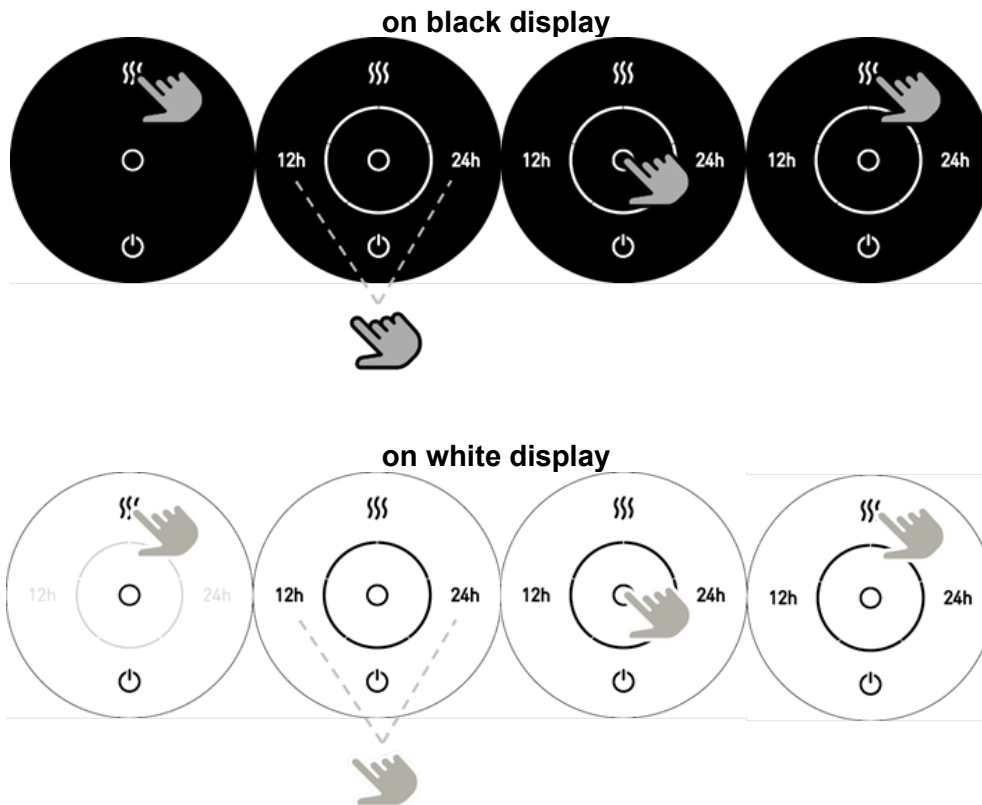

7.3.3 Lock screen

In MANUAL, ANTIFREEZE or TIMER mode, limits the functioning to standby ON/OFF.

In MANUAL, ANTIFREEZE or TIMER mode:

- press and hold and together for 5 seconds until the device beeps twice

To unlock:

- Press and hold and together for 5 seconds until the device beeps twice

NOTE: once lock screen is activated, icon will be always on

7.3.4 Factory reset

Restore to factory settings:

- Boost duration= 2 hours
- 12h Timer duration and 24h Timer duration= 3 hours
- Maximum power level= 100%

In STAND-BY mode:

- press and hold 12h and 24h together for 5 seconds until beep

8 MAINTENANCE

Switch off the mains before any installation, de-installation or maintenance operation on SOLO.

- During installation, de-installation and maintenance, ensure working place safety until the operation is completed.
IMPORTANT: Always disconnect the electricity supply from the mains during installation and maintenance. It is recommended that the fuse is withdrawn or circuit breaker switched off at the distribution board while work is in progress (turning off the switch is not sufficient).
- Never try to modify or repair the SOLO in any of its parts by yourself. Never try to remove any part of the SOLO as water can penetrate inside the regulation box resulting in a risk of electrical shock. Never knock the SOLO against anything. Handle with extreme care during every operation and never leave it in wet areas.

9 DIAGNOSTICS

Description of fault	Operations
SOLO regulation mode is selected at maximum power level and the el. dryer doesn't heat at all	The product must be replaced, please contact customer service.
LEDs are ON but the el. dryer doesn't heat	<ul style="list-style-type: none">• Wait for 2 hours• If the situation doesn't change, contact the customer service
In case of anomalous or strange working condition or if SOLO has visible signs of damage	<ul style="list-style-type: none">• Disconnect the SOLO from the mains• switch off the omnipolar switch immediately• send SOLO to the seller for investigation or replacement.
DISPLAYED ERROR: flashing icons	FAULTY NTC BOARD <ul style="list-style-type: none">• Switch off the 230 V mains

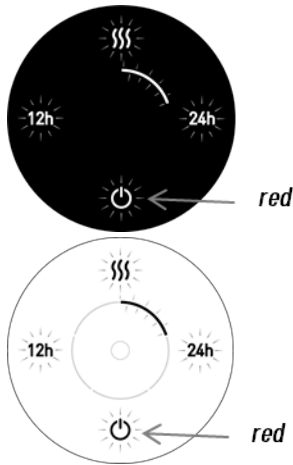

- SOLO internal temperature is anomalous

OR

- SOLO has an issue

- If the problem keeps occurring, send SOLO to the seller for investigation or replacement.

Once the problem is solved, the display will stop flashing.

10 SUPPLIED ACCESSORIES, CONSUMABLES AND SPARE PARTS

In the event of malfunctioning or damage, the whole SOLO must be replaced. No spare parts are available. If the SOLO regulating box shows some plastic cracks, please contact the seller for replacement.

SOLO power supply cable cannot be repaired. If it is damaged, it must be replaced by the manufacturer, its service agent or similarly qualified persons in order to avoid a hazard. Never try to modify or repair the SOLO in any of its parts by yourself. Never try to remove any part of the SOLO as water can penetrate inside the regulation box resulting in a risk of electrical shock. Never knock the SOLO against anything. Handle with extreme care during every operation and never leave it in wet areas.

11 POWER CABLE REDUCTION

The length of the power supply cable SOLO can be reduced to allow its direct installation in a wall box or connection to a terminal designed for the cable, i.e. it is certified and rated for the given type of installation (e.g. an electric plug with an integrated switch).

CAUTION! The cable must extend at least 300 mm from the inlet to the heating unit, the thermostat receiver or regulator (according to the equipment installed) after it has been cut. No warranty claim or repair will be accepted, including defects not related to the shortening of the cable, if the length of the cable is less than 300 mm.

The reduction may only be carried out by a person with the appropriate electrical expertise! The external insulation of the cable and the insulation of individual conductors must remain intact. Avoid using cables with broken insulation.

All connections/wiring must be in compliance with the legislation of the country where the installation is performed, as well as with the rules for use in specific environments (e.g. bathrooms), the IEC 60364-7-701 standard in particular.

In this case, the rated degree of protection, IPX4, as declared by the manufacturer of

the product, will not apply to the reduced end of the cable and/or any terminal.

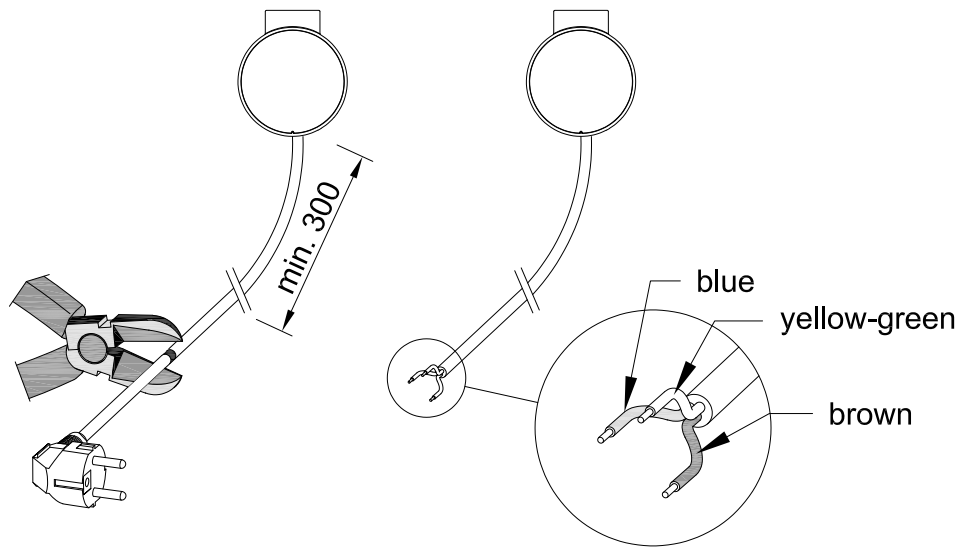

The wiring of Class I equipment is as follows:

Brown (black):	L	phase 230 V / 50 Hz
Blue:	N	neutral conductor
Yellow-green:	PE	protective conductor (earth)

The manufacturer assumes no responsibility for any damage to the equipment or personal injury caused by improper installation of the cable, reversed polarity, insulation damage or any other intervention, connection or wiring that is not in compliance with the applicable regulations.



06/23 800341188_EN_QR